

User Manual for Smartphone Kit # 7800-208

Works with Ductless Mini-Split Models:

B-SVH09SB-0

B-SVH09SB-1

B-SVH12SB-0

B-SVH12SB-1

B-SVH18SB-1

B-SVH24SB-1

B-DVH09SG-0

B-DVH09SG-1

B-DVH12SG-0

B-DVH12SG-1

B-DVH18SG-1

B-DVH24SG-1

B-VMH09SU-1

B-VMH12SU-1

B-VMH18SU-1

B-VMH24SU-1

B-KMH09SU-1

B-KMH12SU-1

B-KMH18SU-1

B-KMH24SU-1



IMPORTANT NOTE:

Read this manual carefully before installing or connecting your Smart kit (Wireless module). Be sure to save this manual for future reference.

Contents

SPECIFICATIONS		1
PRECAUTIONS		1
DOWNLOAD AND INSTALL APP		1
INSTALL SMART KIT (wireless module)		2
USER REGISTRATION		3
NETWORK CONFIGURATION	Android	4
NETWORK CONFIGURATION	iOS	8
HOW TO USE THE APP		12

SPECIFICATIONS

Model: OSK102,EU-OSK103,US-OSK103

Standard: IEEE 802. 11b/g/n

Antenna Type: Printed PCB Antenna

Frequency : WLAN 2400~2483.5 MHz

Operation Temperature:0 C~45 C/32 F~113 F

Operation Humidity: 10%~85%

Power Input: DC 5V/300mA

Maximum Transmitted Power: 19.8dBm Max

PRECAUTIONS

Applicable system: iOS, Android.

(Suggest: iOS 8.0 or later, Android 4.0 or later)

Please be sure your device is running the latest operating system

DOWNLOAD AND INSTALL THE APP

Please use the Nethome Plus QR code below, designated for your smart device.



Android



iOS

Android Phone users: scan Android QR code or go to google play, search "NetHome Plus" app and download.

iOS users: scan iOS QR code or go to APP Store, search "NetHome Plus" app and download.

INSTALL SMART KIT (wireless module)

1. Remove the protective cap of the smart kit (wireless module)
2. Open the front panel and insert the smart kit (wireless module) into the reserved interface.
3. Attach the QR device code packed with Smart kit (wireless module) to the side panel of the machine, ensure it is accessible to be scanned by your mobile phone. Alternatively, you can take a photo of the QR Code and save it into your phone.

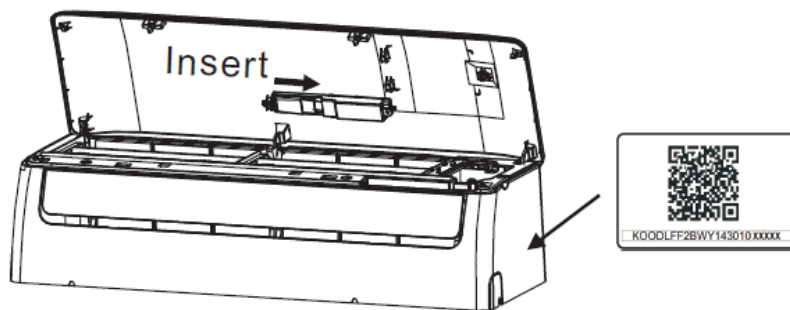
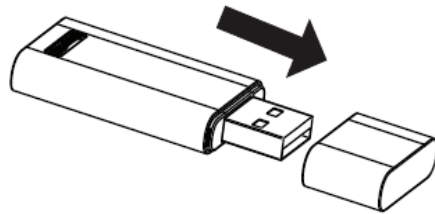

WARNING

This interface is only compatible with SMART KIT(wireless module) provided by the manufacturer.

USER REGISTRATION

Please ensure your mobile device is connected to the wireless router and the wireless router is connected to Internet before performing user registration and network configuration.

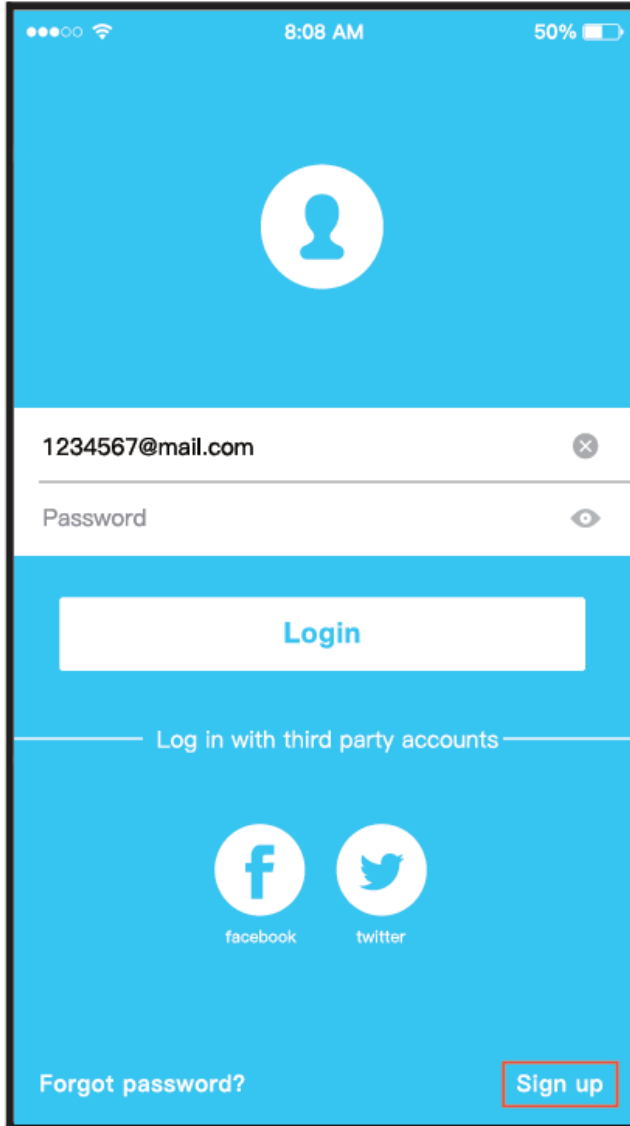

Click "Sign up "

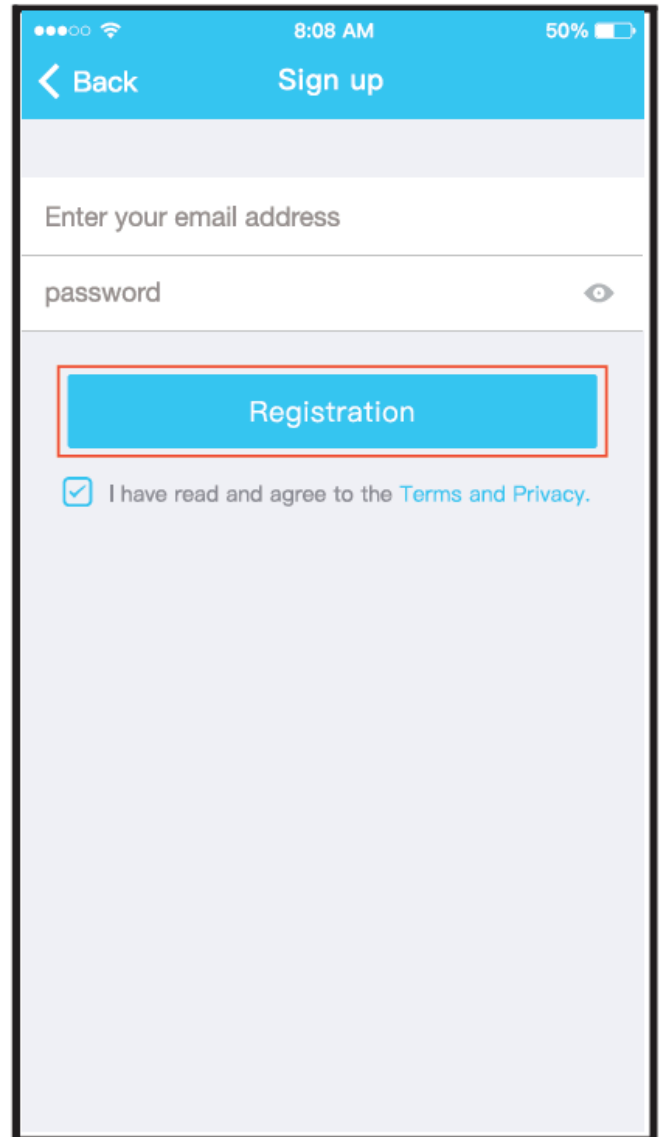

Enter your email address and password, and then click "Registration"

NETWORK CONFIGURATION

Caution:

Make sure the Android or iOS device wireless function can connect back to your original wireless network automatically.

NOTE:

You must finish all the steps in 8 minutes after powering on air conditioner, otherwise you will need to repeat the setup.

Configuring to an Android device

1. Make sure your mobile device has already been connected to the wireless network you intend to use.

Note: It may be necessary to forget other networks as these may interfere with the configuration process.

2. Disconnect power supply to the air conditioner at the breaker panel or exterior disconnect switch.
3. Reconnect the power supply and press the "LED DISPLAY" or "DO NOT DISTURB" button seven times within ten seconds.
4. When the display shows "AP" the unit is in setup mode.

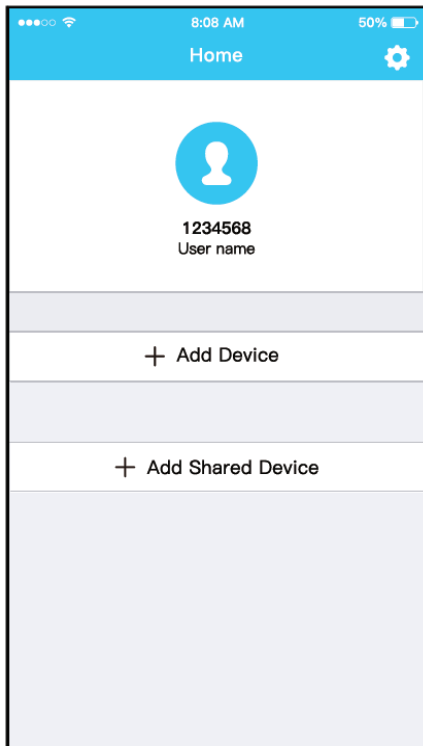

Press "Add Device"

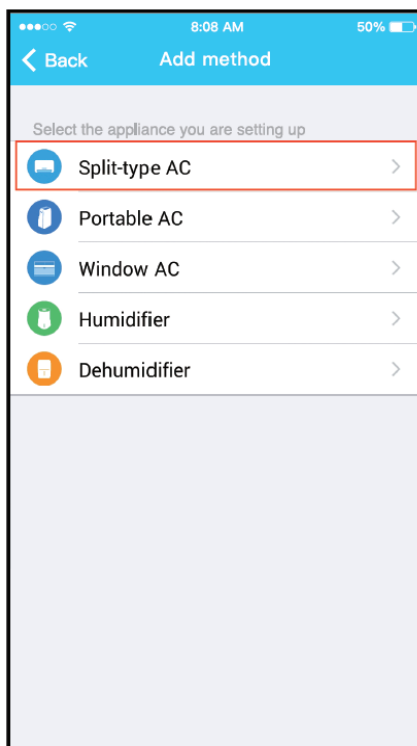

Select the appliance you are setting up

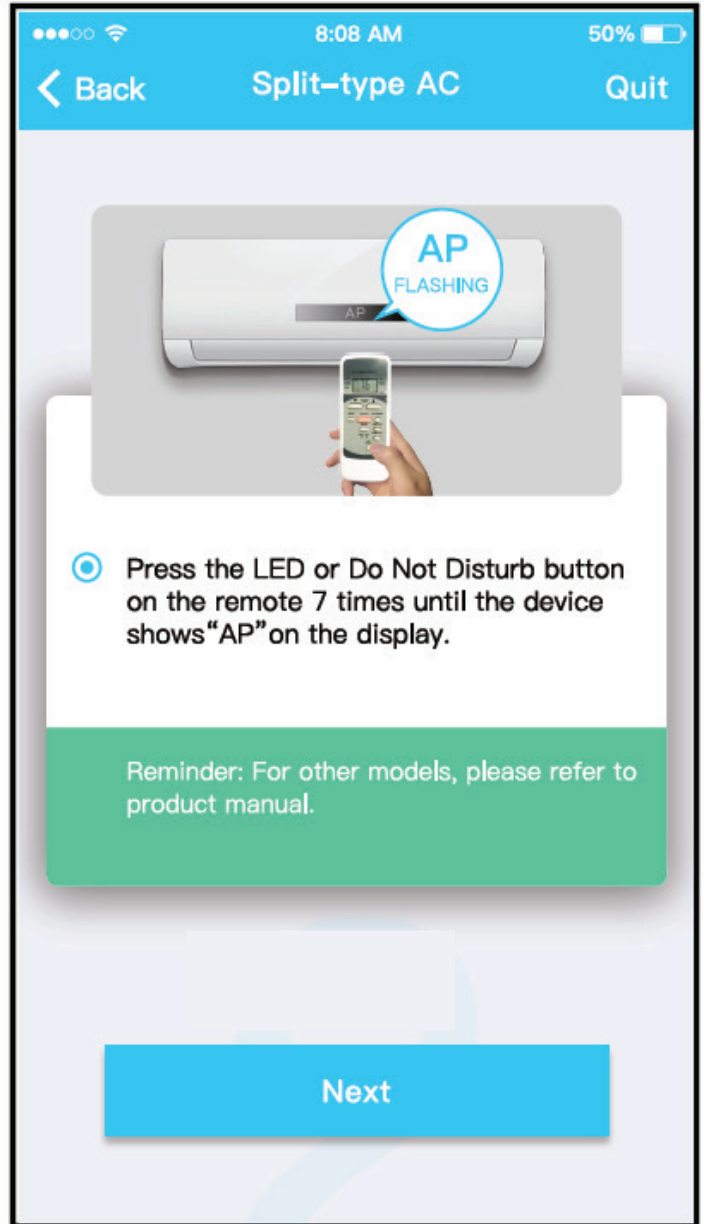
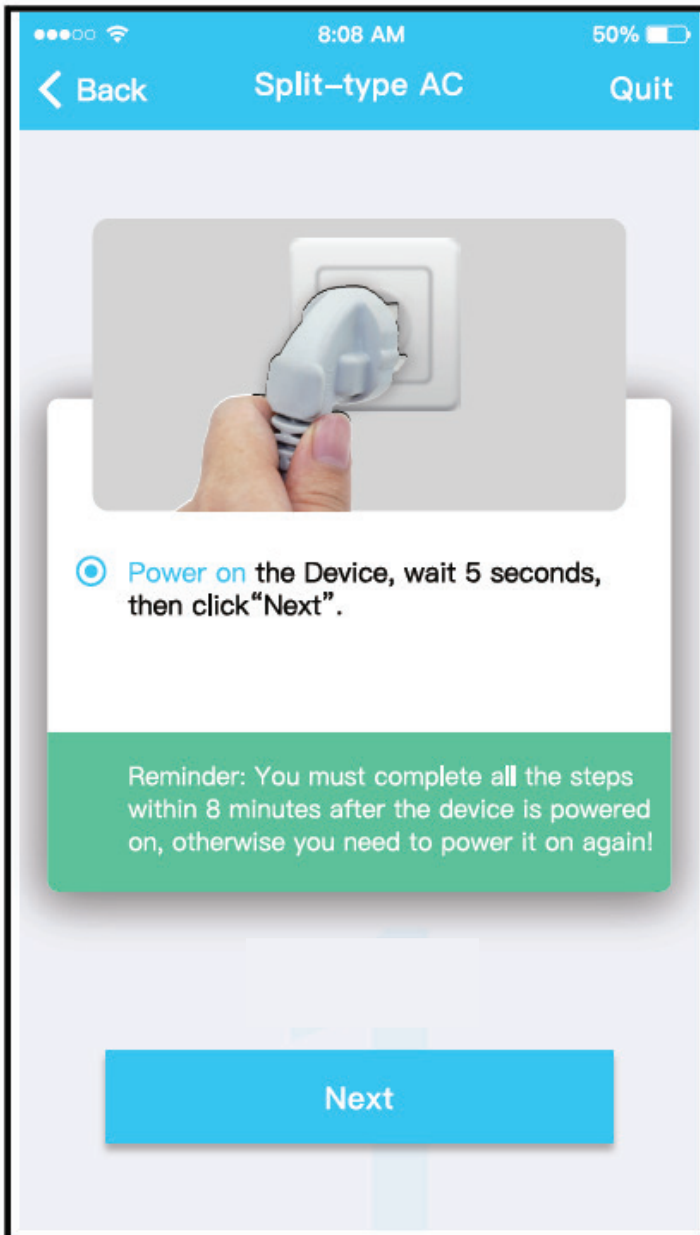

Follow the above steps to enter "AP" mode



Choose "Scan QR code"



Scan the code provided with your Smart Kit

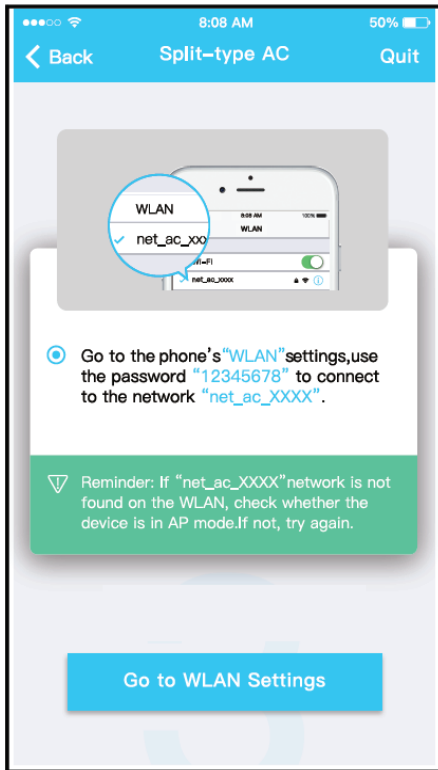

Or choose the "manual setup" method

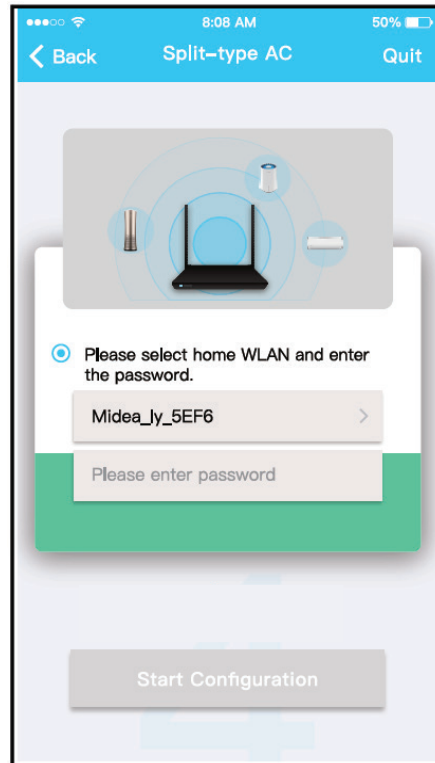

Enter password

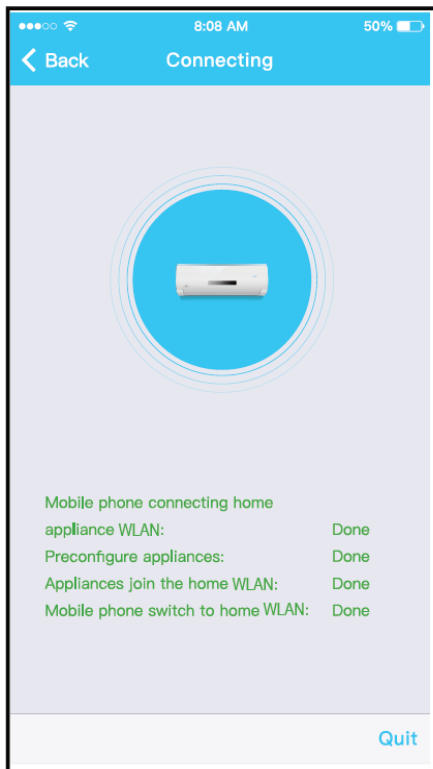

Network configuration Successful

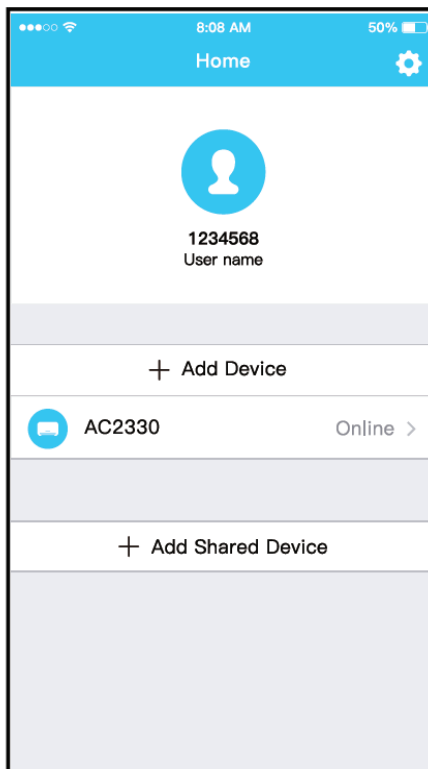

Device is visible on the list

Configuring to an iOS device

1. Make sure your mobile device has already been connected to the wireless network you intend to use.
Note: It may be necessary to forget other networks as these may interfere with the configuration process.
2. Disconnect power supply to the air conditioner at the breaker panel or exterior disconnect switch.
3. Reconnect the power supply and press the "LED DISPLAY" or "DO NOT DISTURB" button seven times within ten seconds.
4. When the display shows "AP" the unit is in setup mode.

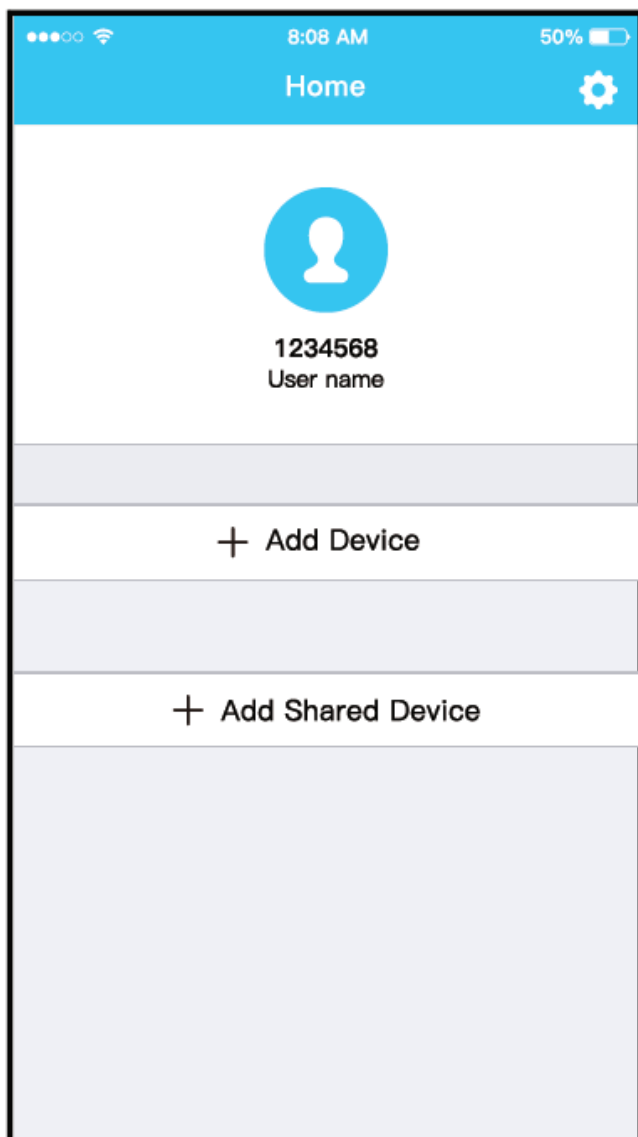

Press "Add Device"

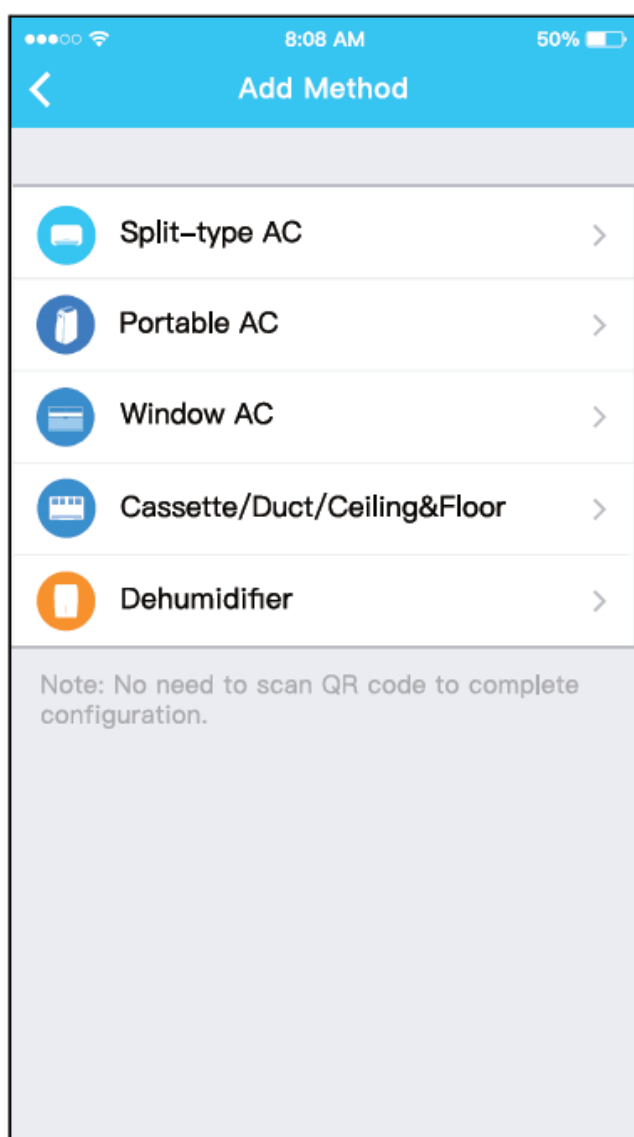

Select the appliance you are setting up

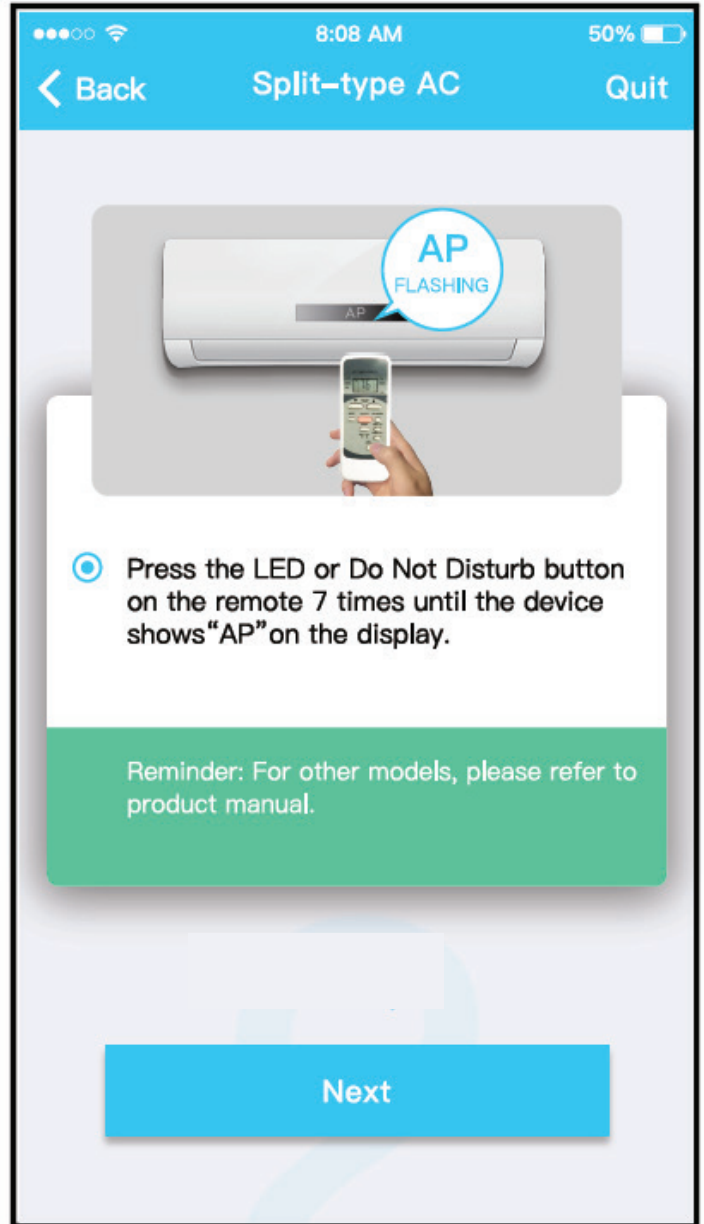
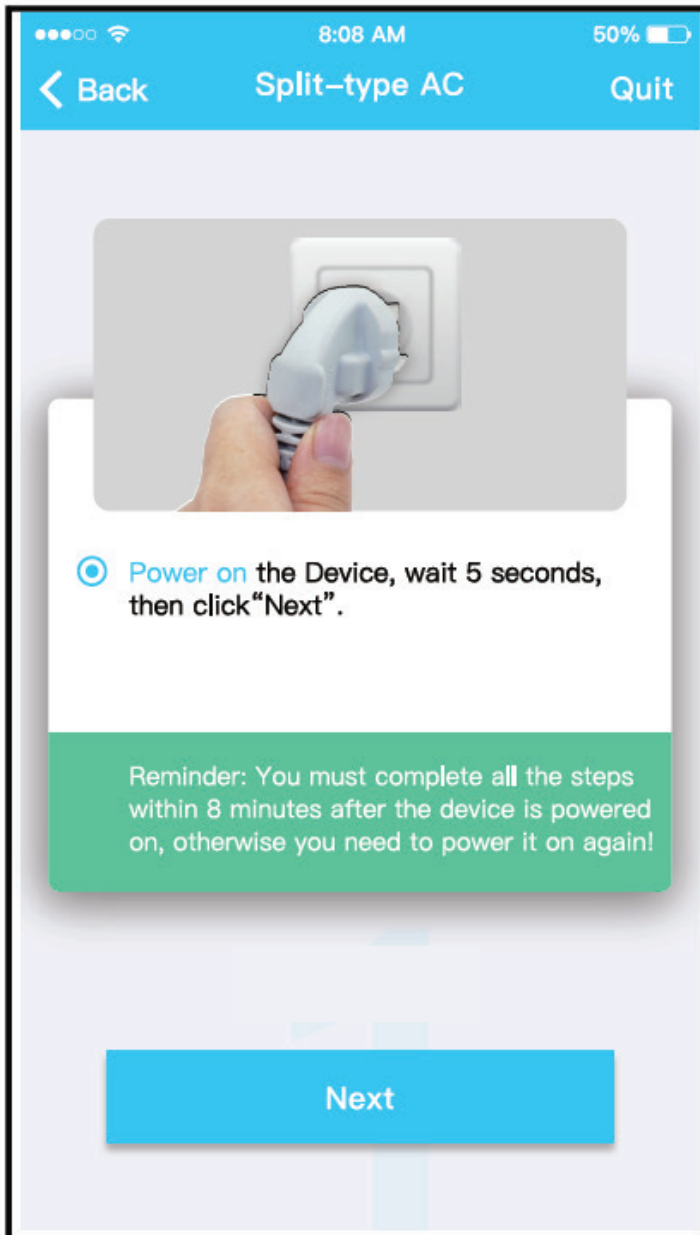

Follow the above steps to enter "AP" mode

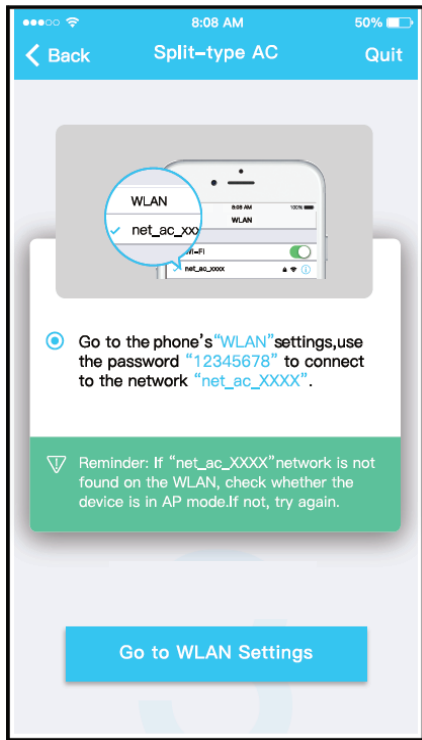

Connect to the wireless network

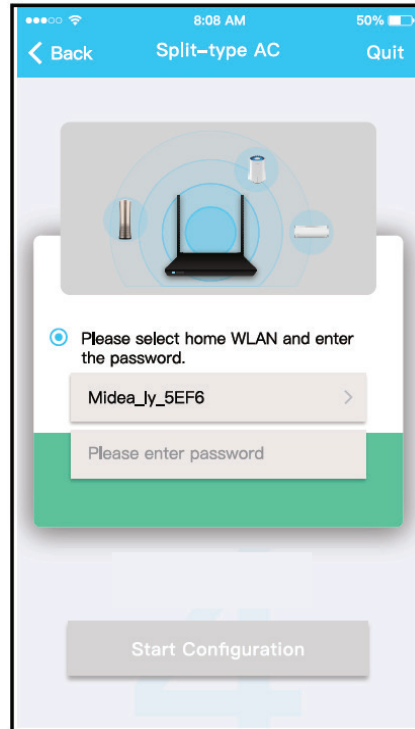

Enter password

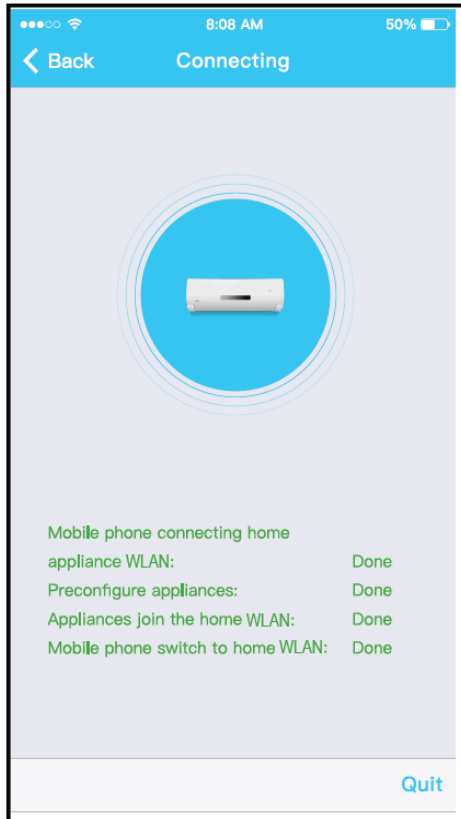

Network configuration Successful

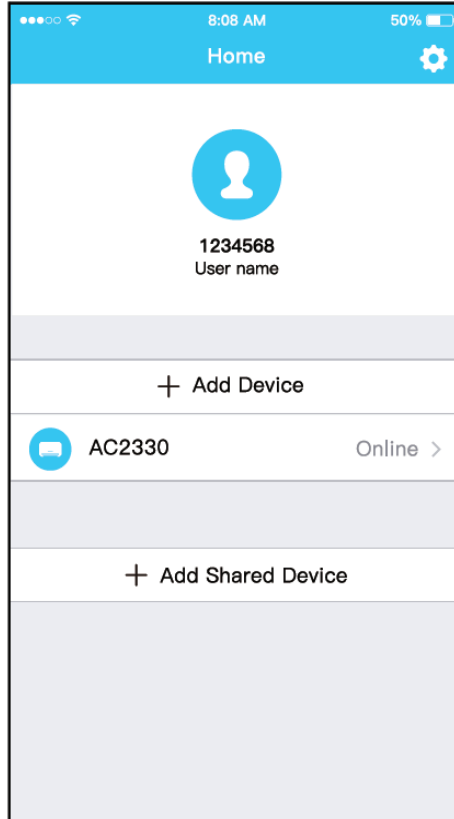

Your device should be visible on the list

NOTE:

When finishing network configuration, APP will display success cue.

If the device status displays "offline", refresh the device list on the APP and verify that status returns to "online".

Alternately, user can power down the unit, re-apply power, and the device status should return to online status after a few minutes.

HOW TO USE THE APP

Please ensure both your mobile device and air conditioner are connected to the internet before using app to control the air conditioner via internet.

Please perform the following steps:

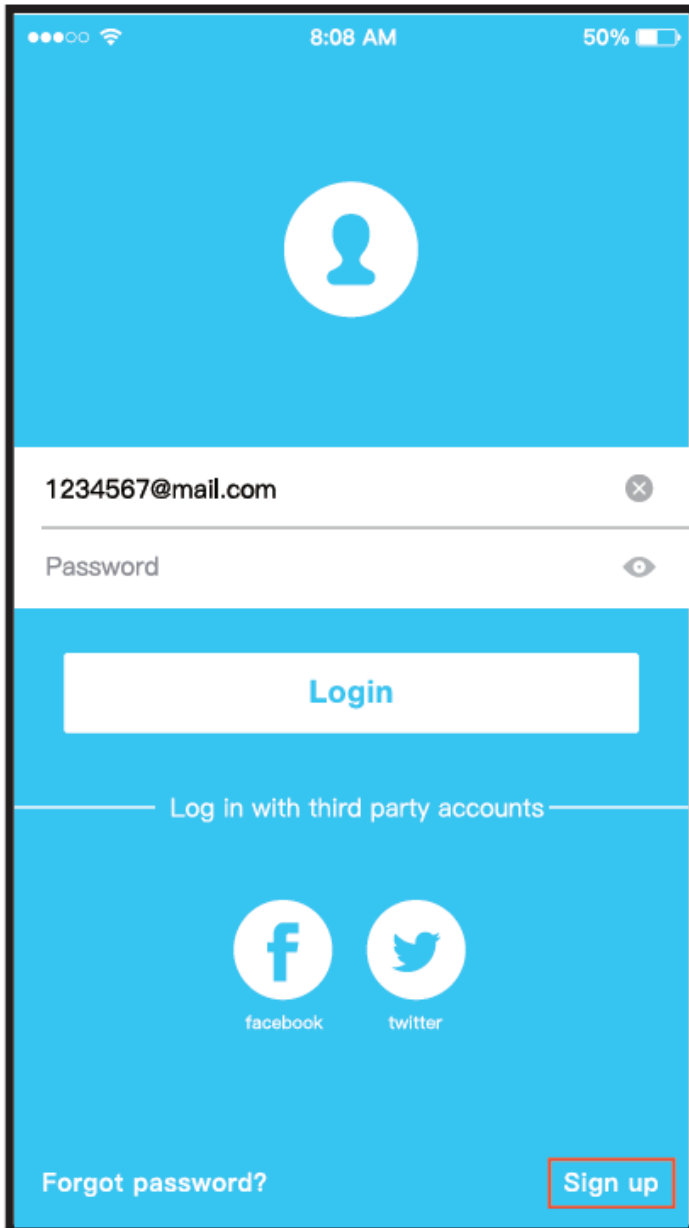

Click "Sign up"

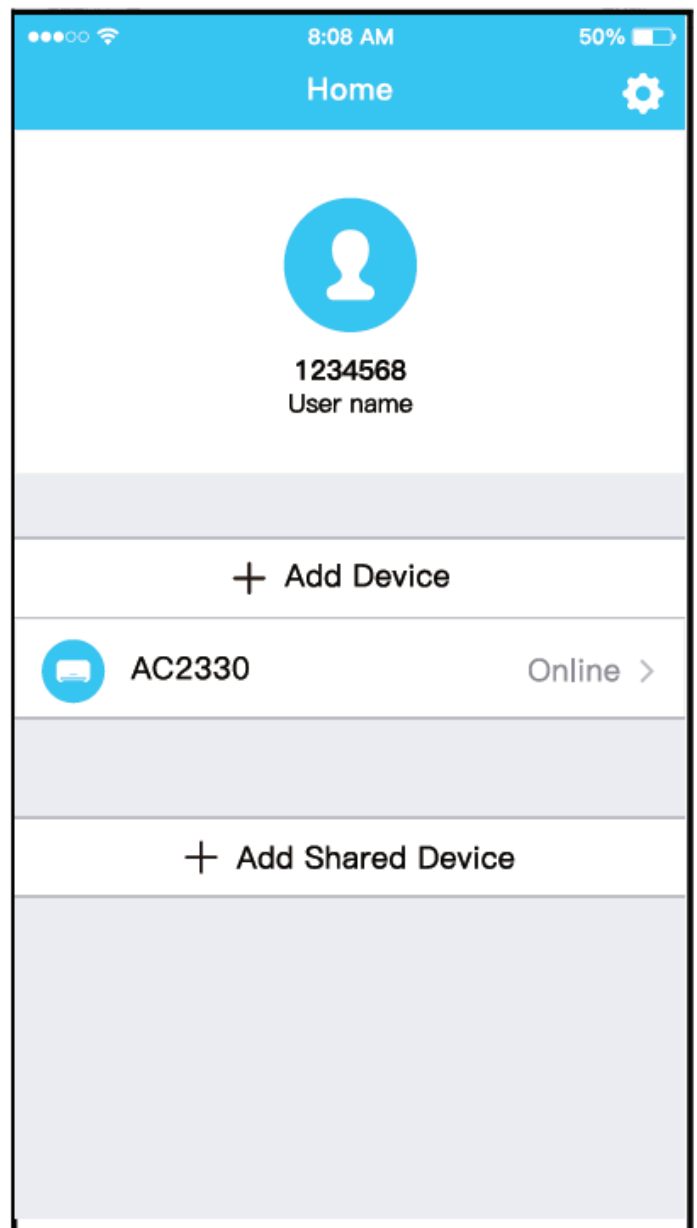

Choose your device from the list

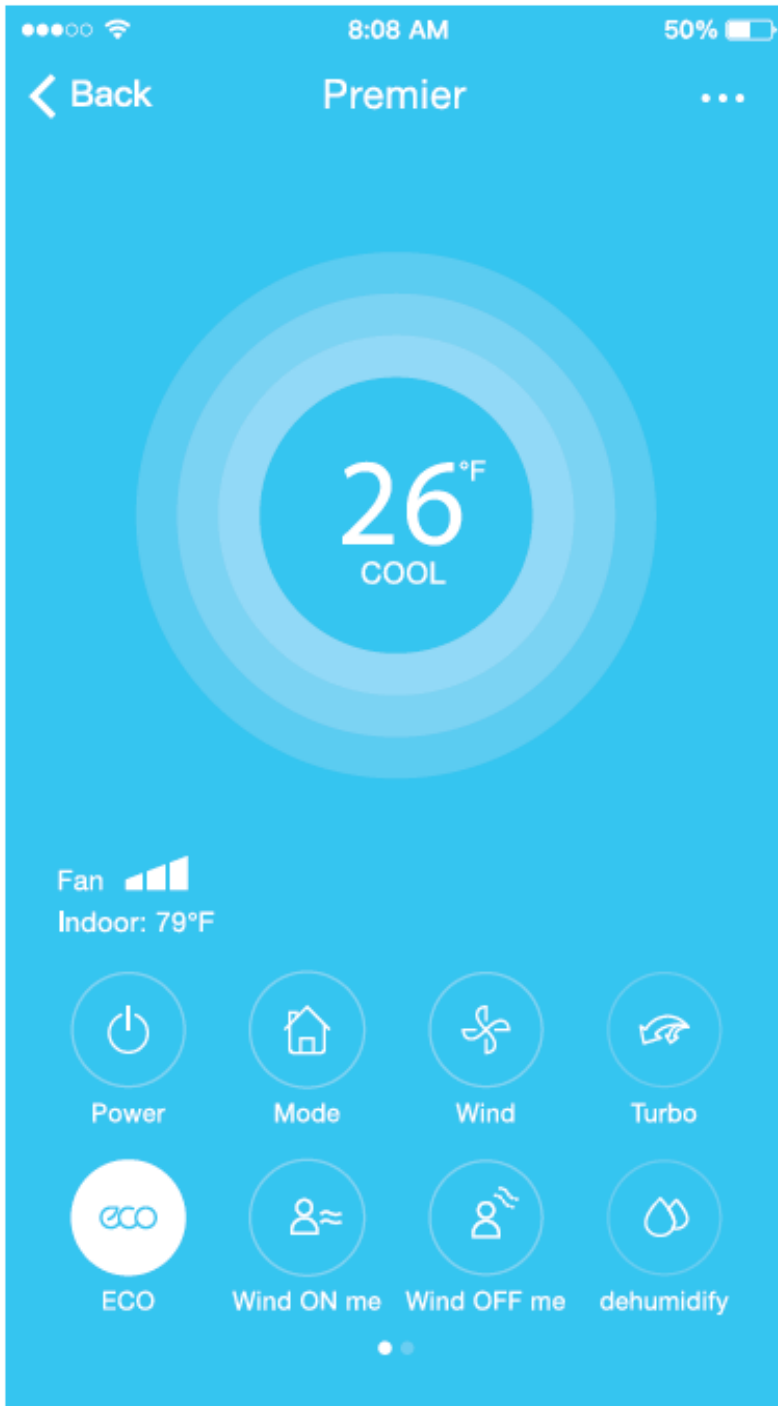

You now should be able to control your device's on/off status, operation mode, temperature setting and fan speed as well as other settings, depending on your device.

NOTE:

Not all functions of this APP are available on every air conditioning unit Please check the equipment user manual for more information.

